

DATASHEET – DIMENSIONS

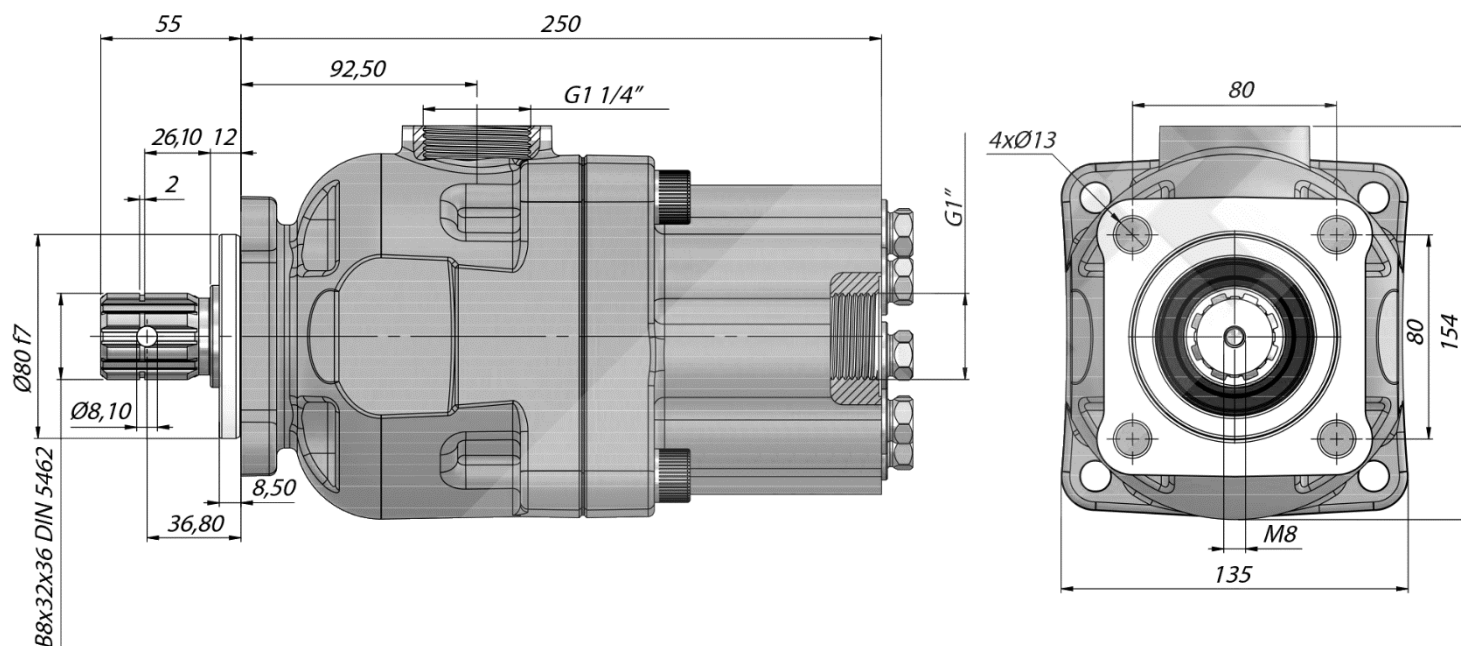

Weight:	81,1 L/min
Flow:	19 kg
Max. constant pressure:	270 bar
Max. intermittent pressure (20 sec):	285 bar
Max. current pressure (6 sec):	300 bar
Max. constant revolutions:	1500 rpm
Min. revolutions:	300 rpm
Suction thread:	1 1/4"
Pressure thread:	1"
Direction of rotation:	DA
Number of pistons:	9